



**"Sınırlarınızı** | since  
Belirliyoruz" | **1972**



[www.konaktelcit.com](http://www.konaktelcit.com)





# KONAK® TEL ÇİT SİSTEMLERİ

## HAKKIMIZDA

50 Yıllık tecrübe ile 1972 yılında temelleri atılan Konak Tel Çit Sistemleri, bugün dünyanın dört bir yanında 36 farklı güvenlik ürünüyle imalat yapan, hizmet sunan ve 19 ülkeye ihracat yapan bir sektör lideridir.

Panel Çit Double Panel Çit, Yüksek Güvenlikli Panel Çit, Dekoratif Çim Çit, Fens Teli, Beton Direk, Altıgen Burgulu Tel, Jiletli Tel, Dikenli Tel, Panel Kapı ve çok geniş ürün yelpazemizle sınırlarınızı belirlemek için yanınızdayız.

Aksaray Organize Sanayi Bölgesinde bulunan 2 fabrikamız , birincisi 24.000 m2 açık alan ve 20.000 m2 kapalı alana sahip, ikincisi ise 4.000 m2 açık alan ve 2.000 m2 kapalı alana sahiptir.

Yıllık 800.000 m2 panel çit, 400.000 m2 fens teli, 550.000 adet beton direk, 1.000.000 m2 altıgen burgulu tel imalatı yapan firma her geçen gün emin adımlarla büyümektedir. Konak Demir Çelik San. ve LTD. ŞTİ. olarak ürün kalitemiz ve sürdürülen müşteri memnuniyeti ile alanımızda öncü firma olmaya devam etmekten gurur duymaktayız.



Projelendirme



Estetik



Dayanıklı



Kusursuz Üretim

“Sınırlarınızı | since  
Belirliyoruz” | 1972



[www.konaktelcit.com](http://www.konaktelcit.com)

Panel it sistemleri ile mülkünüzü korurken  
**ESTETİK BİR GÖRÜNÜM ELDE EDİN**



**"Sınırlarınızı** | since  
Belirliyoruz" | **1972**

[www.konaktelcit.com](http://www.konaktelcit.com)

# SERTİFİKALARIMIZ

Ürünlerimiz Uluslararası Standartlara Uygundur

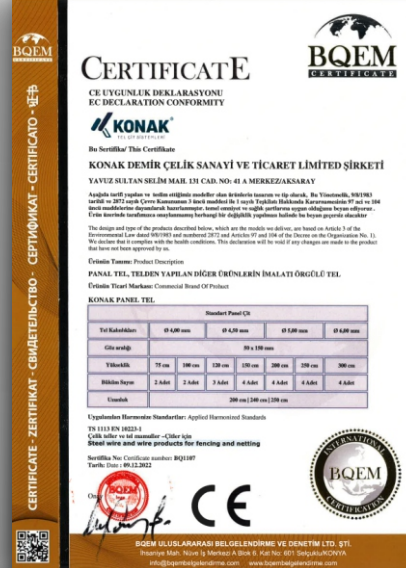

## Neden Konak Tel

- Uzman Kadro
- Kaliteli Ürün
- Ürün Çeşitliliği
- Tecrübe
- Güvenirlilik
- Referanslar



"Sınırlarınızı Belirliyoruz" since 1972

www.konaktelcit.com

## 3D PANEL ÇİT



Wire Thickness Tel Kalınlığı	Ø 4,00*4,00 / Ø 4,50*4,50 mm Ø 4,00*5,00 / Ø 5,00*5,00 mm
Mesh Size Göz Arası	55 mm 150 / 200 mm
Height Yükseklik	1030 / 1230 / 1530 1730 / 1930 / 2030 mm
Length Genişlik	2000 / 2500 / 3000 mm

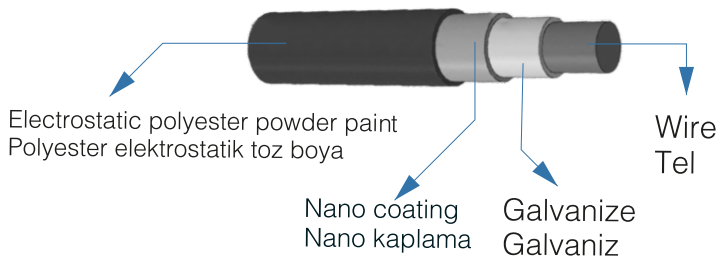
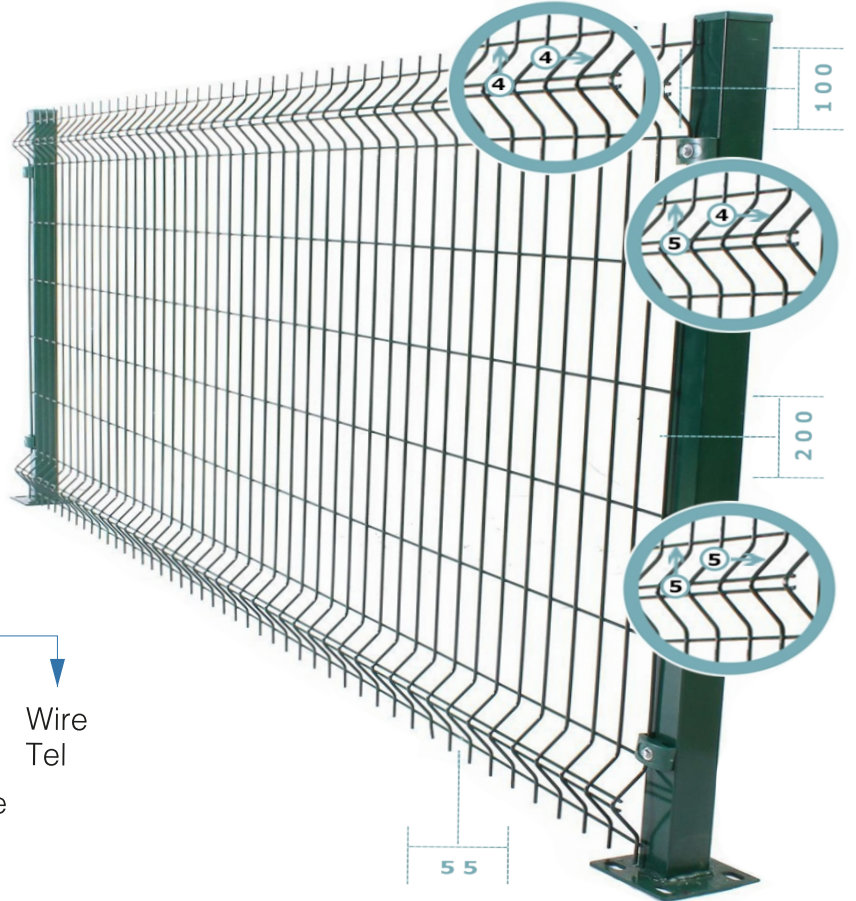
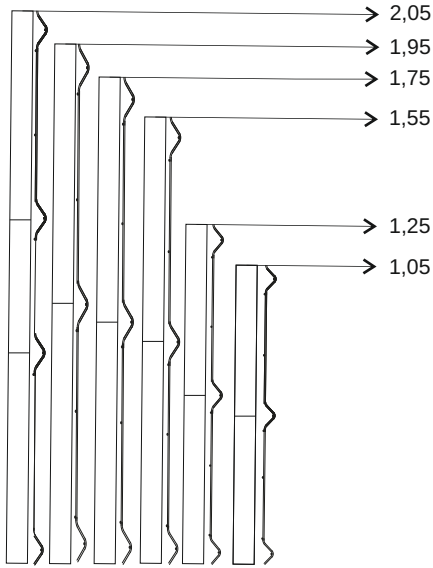

## 2D DOUBLE PANEL ÇİT



Wire Thickness Tel Kalınlığı	Ø 6*5*6 / Ø 8*6*8
Mesh Size Göz Arası	55 mm 150 / 200 mm
Height Yükseklik	1030 / 1230 / 1530 1730 / 1930 / 2030 mm
Length Genişlik	2000 / 2500 / 3000 mm

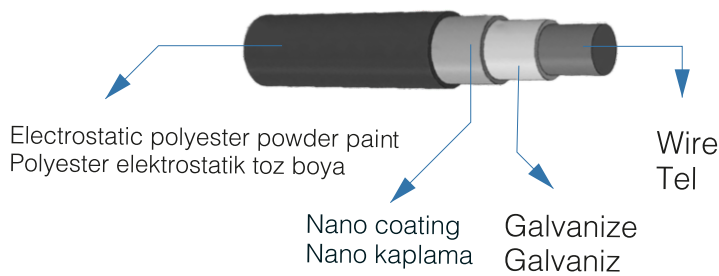
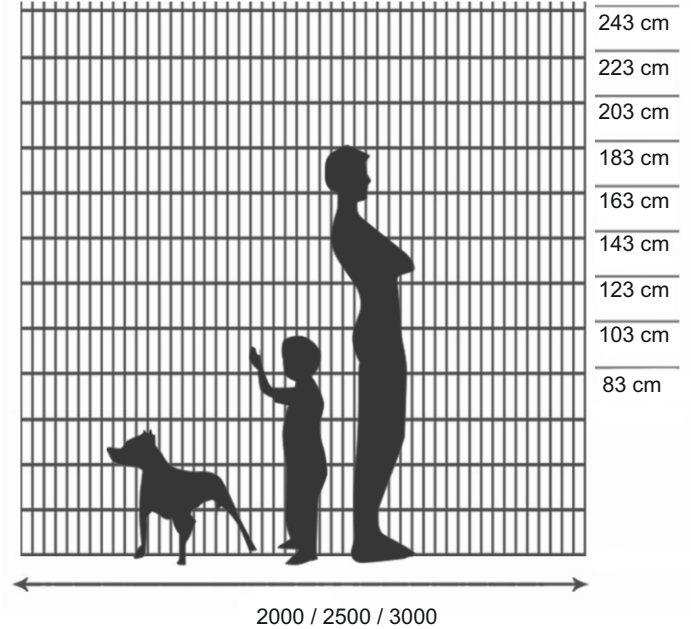
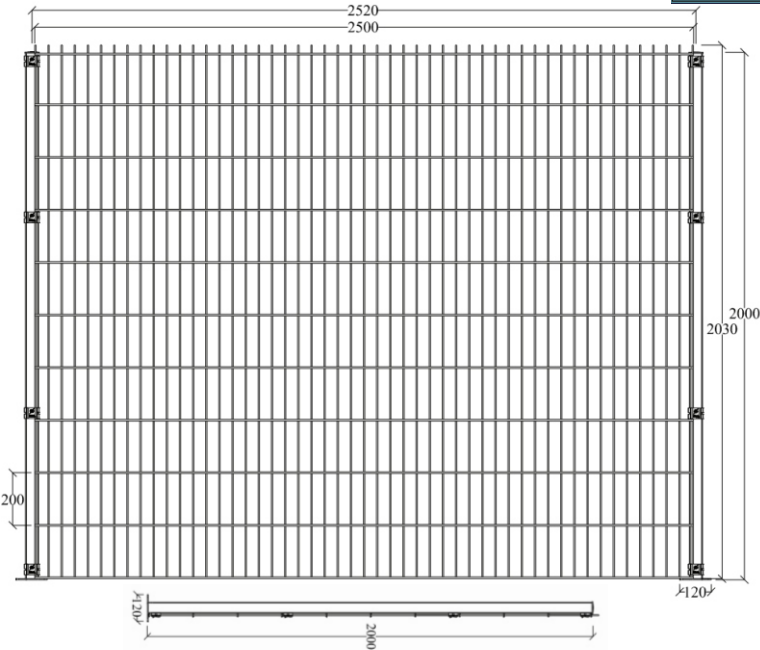

**Güvenlik Ve Dayanıklılığın  
MÜKEMMEL BİR KOMBİNASYONU**

**"Sınırlarınızı | since  
Belirliyoruz" | 1972**

# YÜKSEK GÜVENLİK ÇİTİ



Wire Thickness Tel Kalınlığı	Ø 4,00*4,00 mm / Ø 4,00*6,00 mm
Mesh Size Göz Arası	76,2 x 12,7 mm
Height Yükseklik	1000 .... 3000 mm
Length Genişlik	2010 / 2510 / 3010 mm

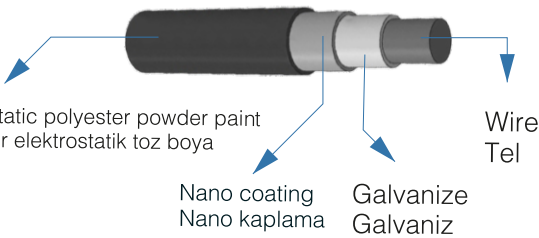
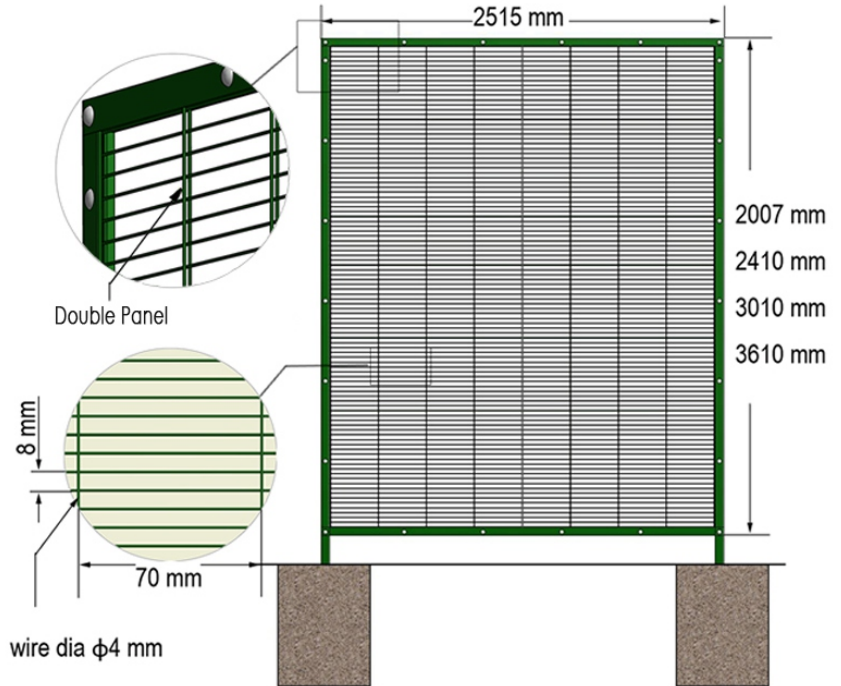
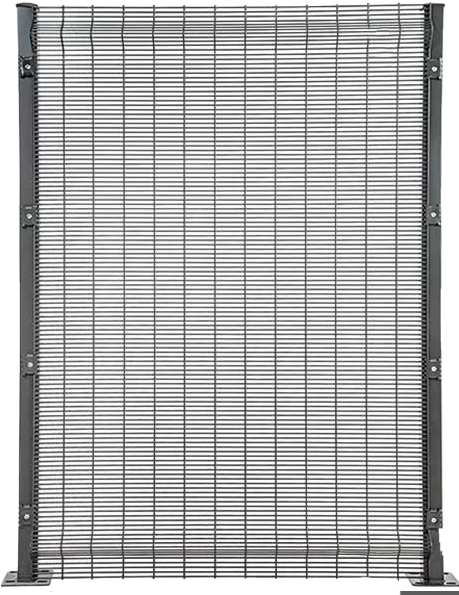

# Huzurlu Bir Yaşam İçin Güvenli Bir Çevre Oluşturun

**"Sınırlarınızı** | since  
Belirliyoruz" **1972**

[www.konaktelcit.com](http://www.konaktelcit.com)

## DEKORATİF GÜVENLİK ÇİT



Wire Thickness Tel Kalınlığı	Ø 4,00*4,00 mm / Ø 4,00*6,00 mm
Mesh Size Göz Arası	76,2 x 12,7 mm
Height Yükseklik	1000 .... 3000 mm
Length Genişlik	2010 / 2510 / 3010 mm

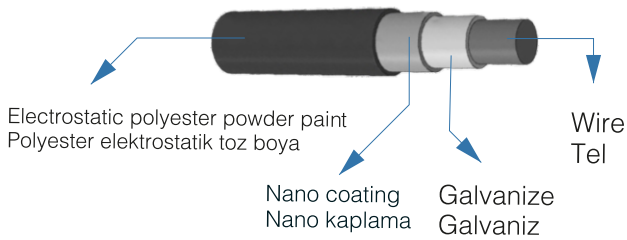
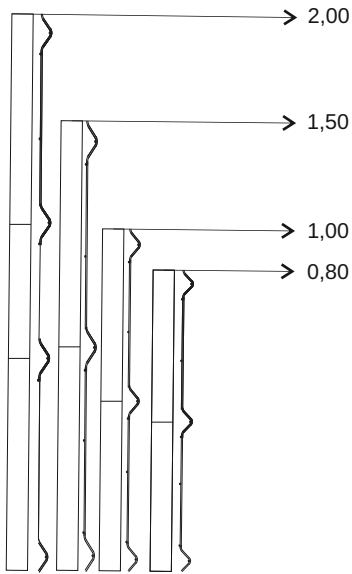

# JİLETLİ PANEL ÇİT



Wire Thickness Tel Kalınlığı	Ø 4,00*4,00 mm Ø 4,50*4,50 mm
Jilet Tipi Blade Type	BTO 28
Mesh Size Göz Arası	55 / 150 / 200 mm
Height Yükseklik	800 / 1000 / 1200 1500 / 2000 mm
Length Genişlik	2500 mm



Electrostatic polyester powder paint  
Polyester elektrostatik toz boya

Nano coating  
Nano kaplama

Galvanize  
Galvaniz

Wire  
Tel

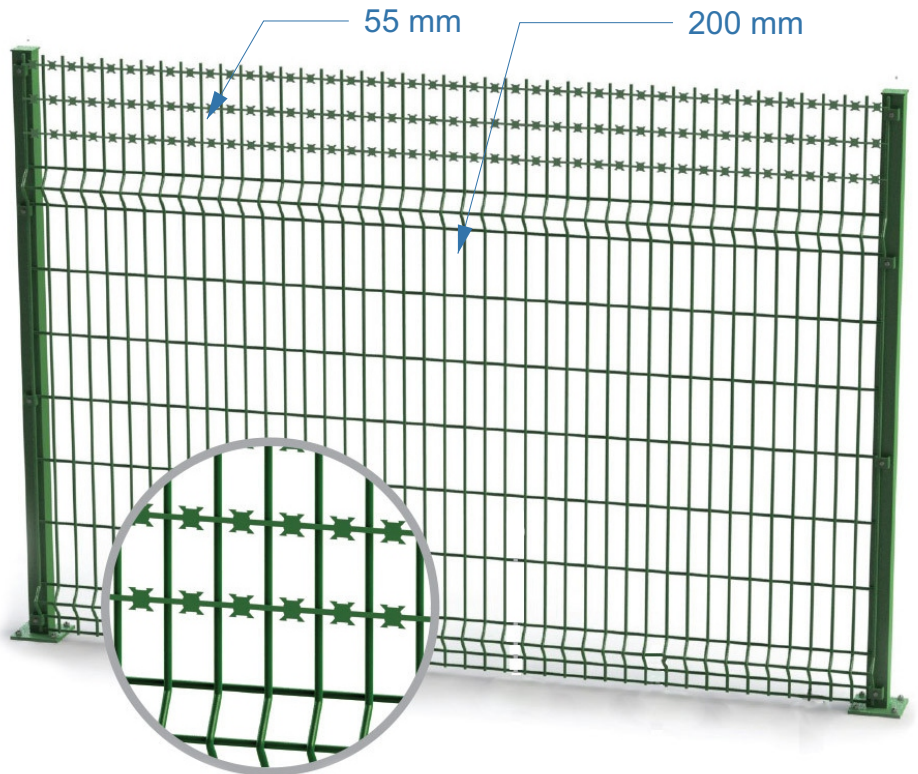
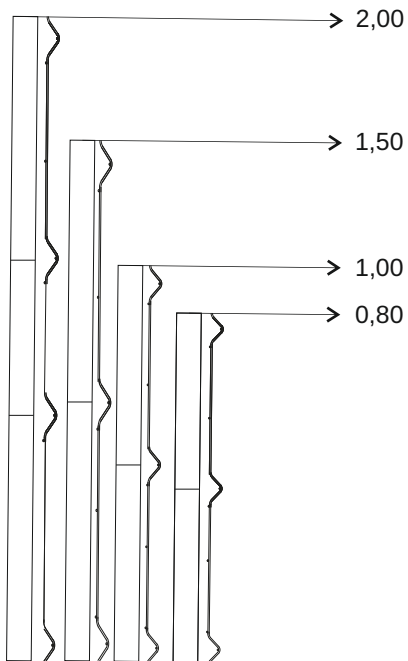

## DEKORATİF DİREK



Height  
Yükseklik

1500 / 1750 / 2000  
2250 / 2450 / 2500 mm

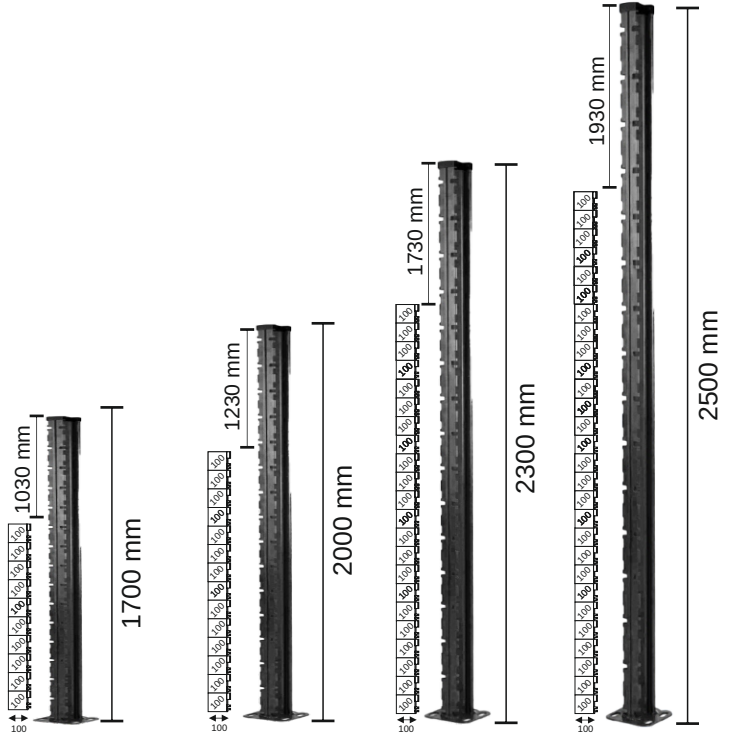
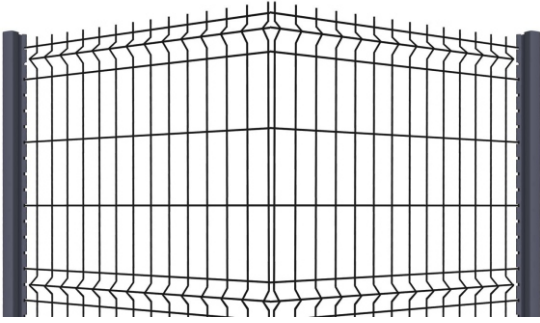

Electrostatic Polyester Powder Paint

Nano Coating

Galvanize

Metal

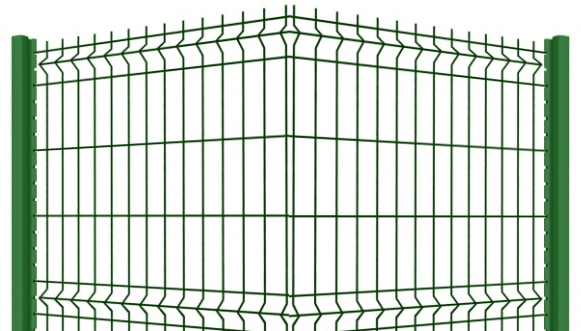
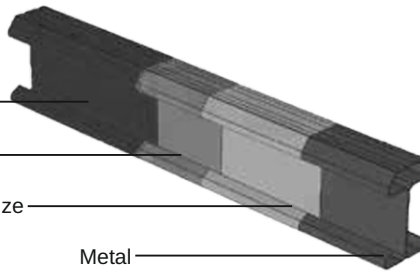



# DIKDÖRTGEN DİREK



Profile Profil	40 x 60 x 1,5 mm 40 x 60 x 2,0 mm
Profile Height Profil Yükseklik	1000 / 1300 / 1500 / 1700 / 2000 2200 / 2400 / 2550 / 2800 / 3000 mm
Flatbar Lama	40 x 4 mm
Flatbar Height Lama Yükseklik	630 / 830 / 1030 / 1230 / 1430 1630 / 1830 / 2030 / 2230 / 2430 mm

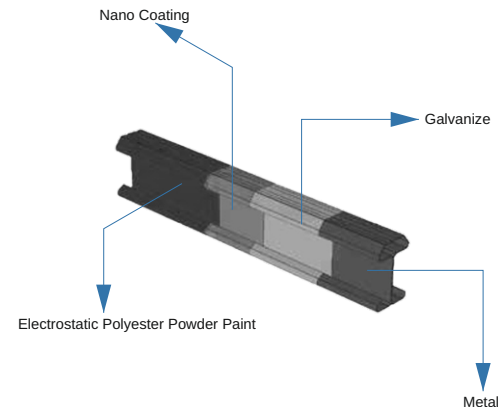
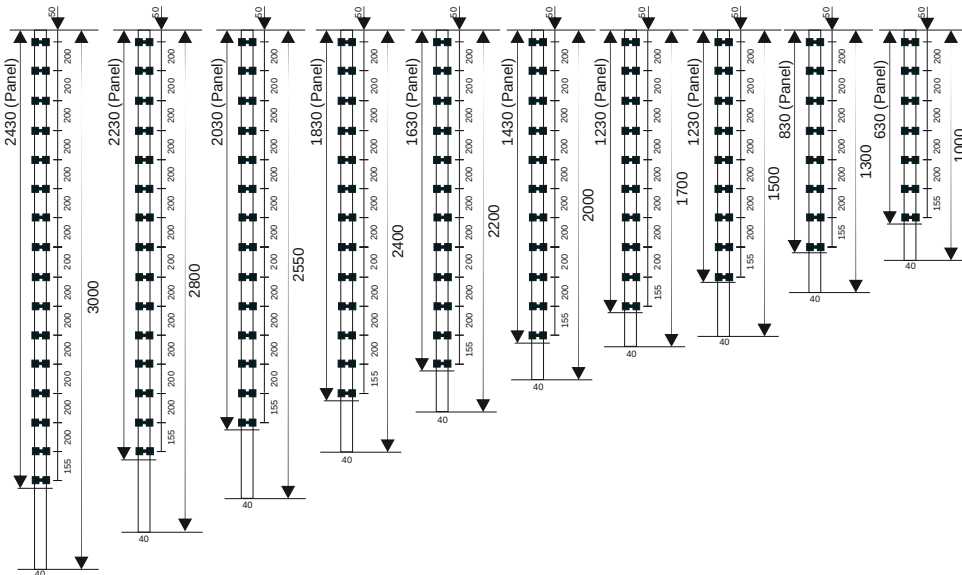
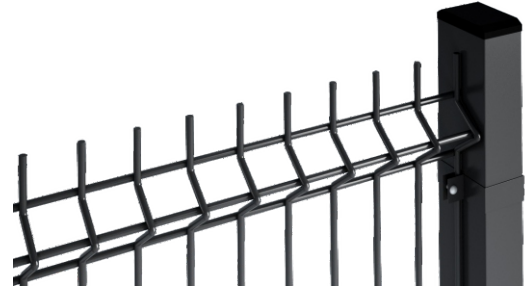

## KUTU PROFİL DİREK



Profile Profil	50x50x1,5 / 50x50x2 60x60x1,5 / 60x60x2 mm
Profile Height Profil Yükseklik	1050 / 1250 / 1550 / 1750 / 1950 / 2050 1500 / 1750 / 2000 / 2250 / 2450 / 2500 mm

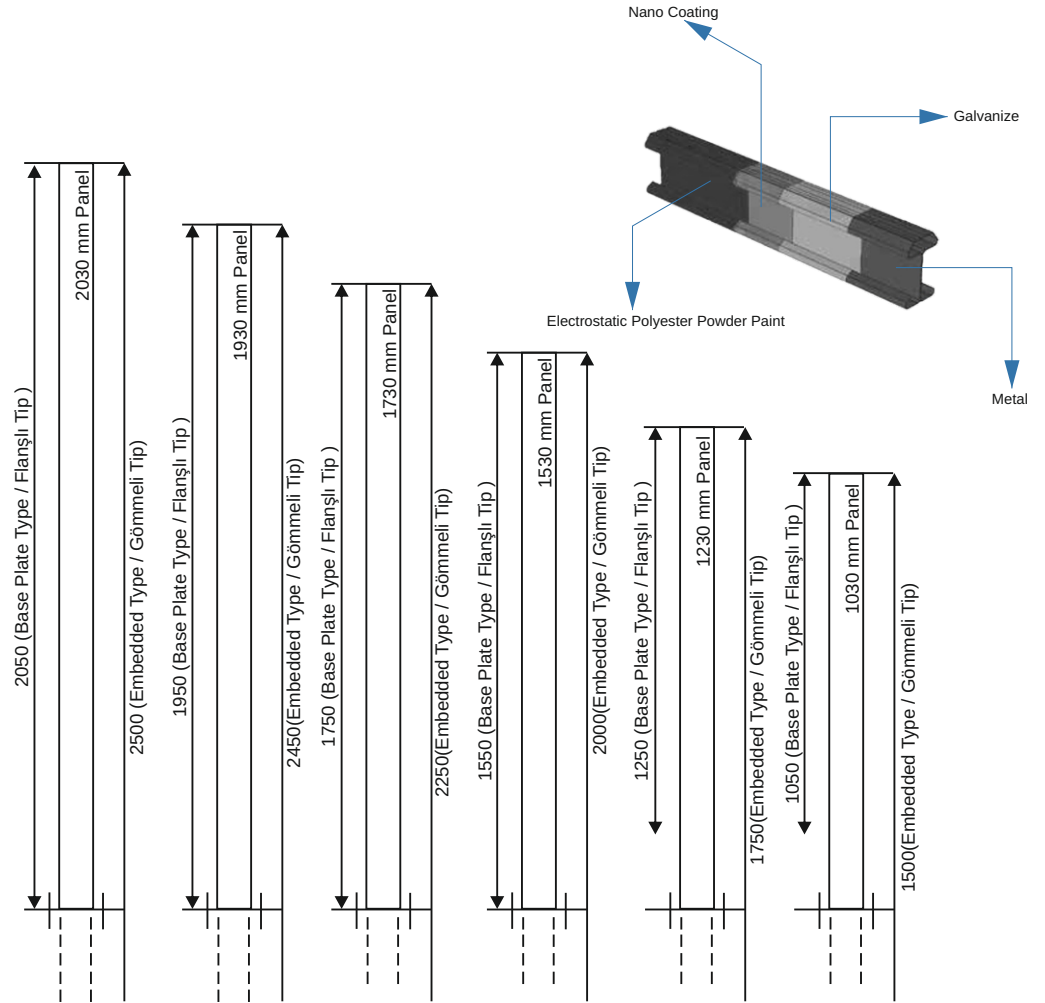

# PANO ÇİT & MOBİL ÇİT

Post Pipe Diameter Direk Boru Çapı	Ø 42 mm
Panel Panel	Single Panel
Foot Ayak	Standard Concrete Foot Standart Beton Ayak
Height Yükseklik	1,50 ..... 2,00 m
Length Genişlik	1,50 ..... 2,00 m

Post Pipe Diameter Direk Boru Çapı	Ø 42 mm
Panel Panel	Pipe / Flatbar Boru / Lama
Height Yükseklik	1,00 ..... 1,50 m
Length Genişlik	2,00 ..... 2,50 m

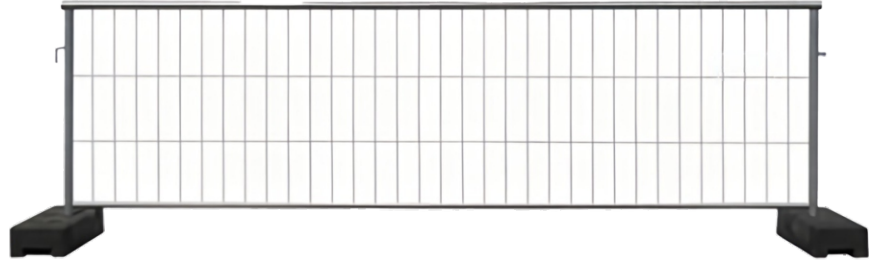

# ÇİM ÇİT



	KNPro	KNMedium
Mesh Size Göz Aralığı	42 ± 2	48 ± 2
Wire dia. Tel Çapı	2 x Ø 1,60 mm	2 x Ø 1,60 mm
Height Yükseklik	1000 / 1200 / 1500 / 2000 mm	1000 / 1200 / 1500 / 2000 mm
Roll Lenght Rulo Uzunluk	10 m	10 m

2x1,6 mm

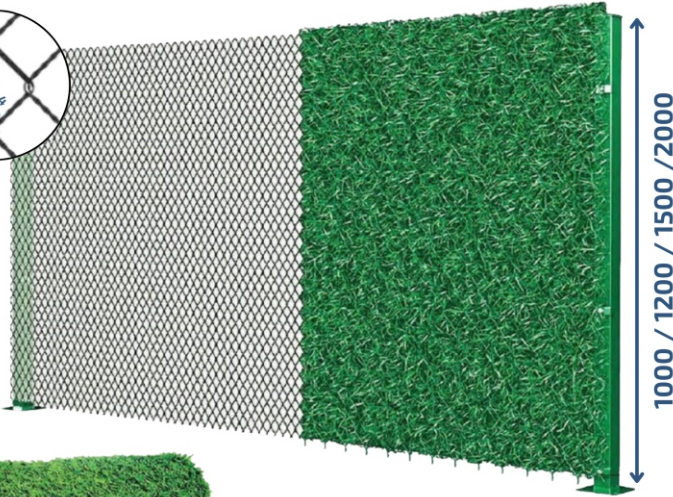
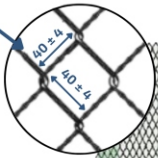

## GALVANİZLİ & PVC KAPLI KAFES TEL



	Galvanized Galvaniz	PVC Coated PVC Kaplı
Mesh Size Göz Aralığı	30x30 / 40x40 / 50x50 60x60 / 70x70 (+/- 4)	30x30 / 40x40 / 50x50 60x60 / 70x70 (+/- 1)
Wire dia. Tel Çapı	Ø 2 .... 4 mm	Ø 3 .... 4,80 mm
Height Yükseklik	800 .... 6000 mm	800 .... 6000 mm
Roll Lenght Rulo Uzunluk	Max 25 m	Max 25 m

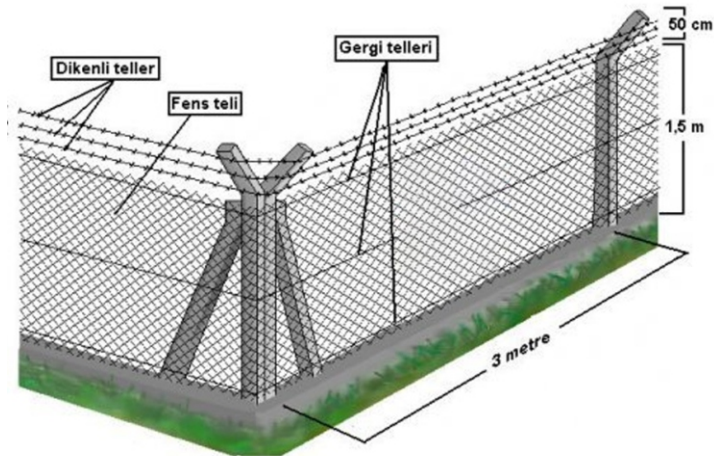

# GABİON DUVAR



Tel Wire	Ø 6*5*6 / Ø 8*6*8 mm
Direk Malzeme Post Material	40x120x3 mm Kutu Profil Sac 40x120x3 mm RHS Profile
Kaplama Coated	Sıcak daldırma galvaniz kaplama Hot dip galvanized
Yükseklik Height	1030 / 1230 / 1430 1630 / 1830 / 2030 mm

Panel	Double Panel
Direk Malzeme Post Material	2 ... 3 mm Sac 2 ... 3 mm Sheel Metal
Kaplama Coated	Sıcak daldırma galvaniz kaplama Hot dip galvanized
Yükseklik Height	1030 / 1230 / 1430 1630 / 1830 / 2030 mm

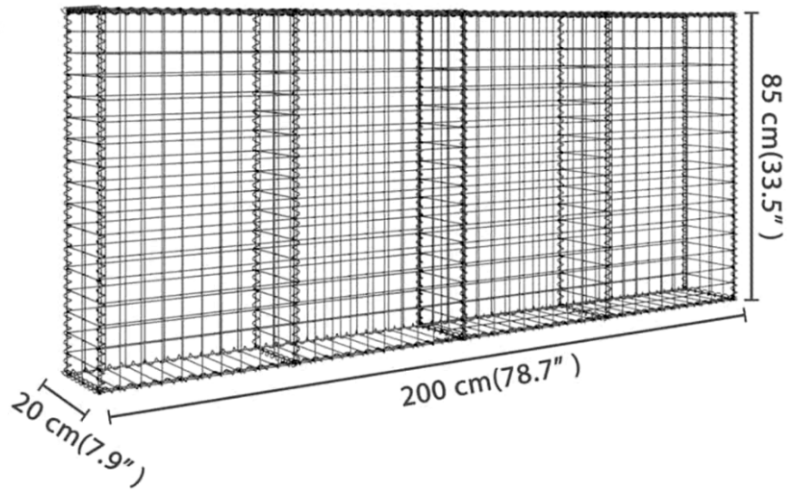
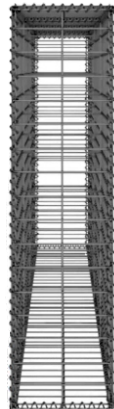
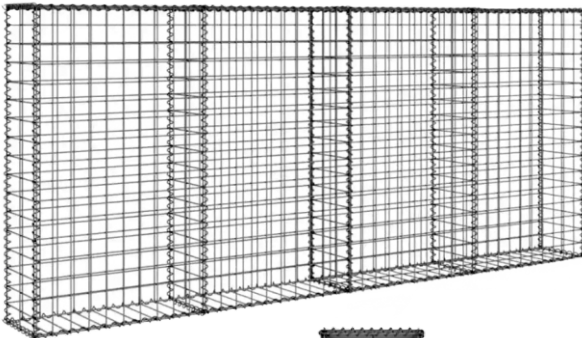
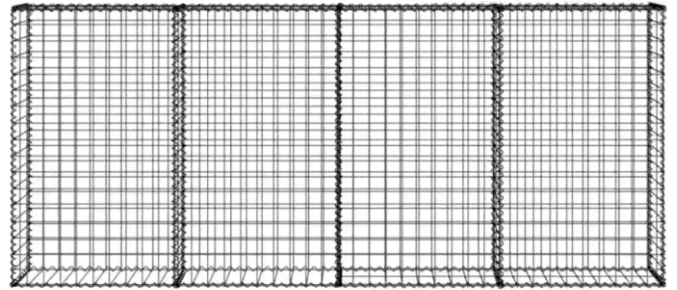

# DIKENLİ & JİLETLİ TEL

## Helezon Jiletli Tel

Wire Tel	Ø 2,50 mm
Material Malzeme	Galvanized Steel wire - 1600 N/mm <sup>2</sup> / 100 / 275 gr/m <sup>2</sup> Galvanizli Çelik tel - 1600 N/mm <sup>2</sup> - 100 / 275 gr/m <sup>2</sup>
Sheet metal Sac	0,50 mm - 100 / 275 gr/m <sup>2</sup> galvanized - SS. 304 / 430 0,50 mm - 100 / 275 gr/m <sup>2</sup> galvaniz - 304 / 430 Kalite paslanmaz
Height Yükseklik	450 / 600 / 900 mm

## Düzlemsel Jiletli Tel

Wire Tel	Ø 2,50 mm
Material Malzeme	Galvanized Steel wire / 1600 N/mm <sup>2</sup> / 100 / 275 gr/m <sup>2</sup> Galvanizli Çelik tel - 1600 N/mm <sup>2</sup> - 100 / 275 gr/m <sup>2</sup>
Sheet metal Sac	0,50 mm - 100 / 275 gr/m <sup>2</sup> galvanized - SS. 304 / 430 0,50 mm - 100 / 275 gr/m <sup>2</sup> galvaniz - 304 / 430 Kalite paslanmaz
Height Yükseklik	450 / 600 / 900 mm
Loop Halka boyu	22,5 cm (450 mm) / 30 cm (600 mm) / 30 cm (900 mm)

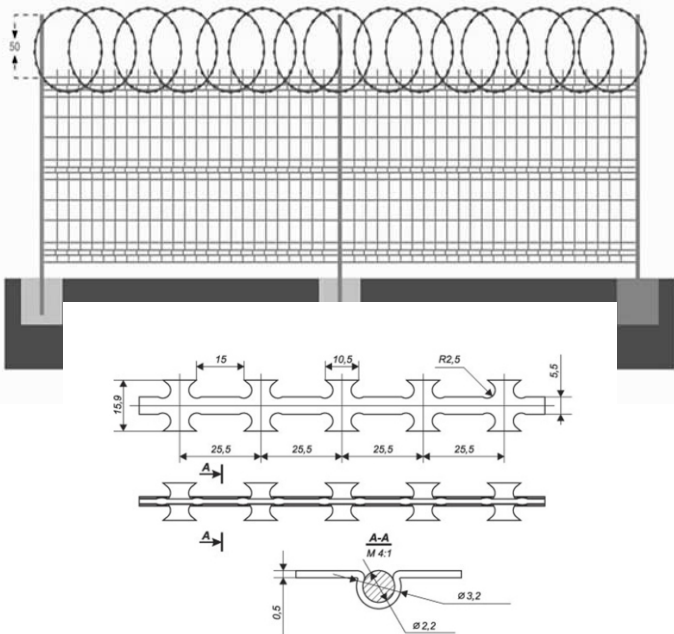
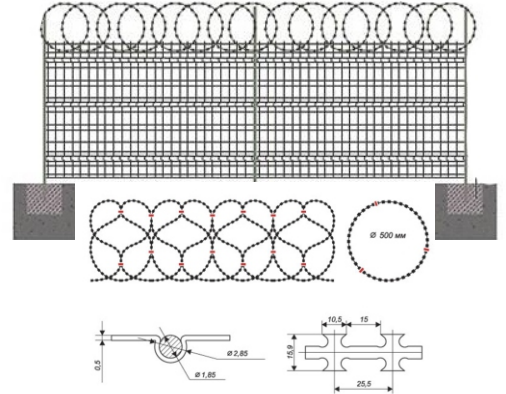

## Dikenli Tel

Wire Tel	Metric type Metrik tip		IOWA type Konvansiyonel tip	
	Line wire Gövde	Barb wire Diken	Line wire Gövde	Barb wire Diken
	Ø1,60 mm	Ø 1,60 mm	Ø 2,40 mm	Ø 1,90 mm
Material Malzeme	Galvanized Steel wire - 100 / 275 gr/m <sup>2</sup> Galvanizli Çelik tel - 100 / 275 gr/m <sup>2</sup>			

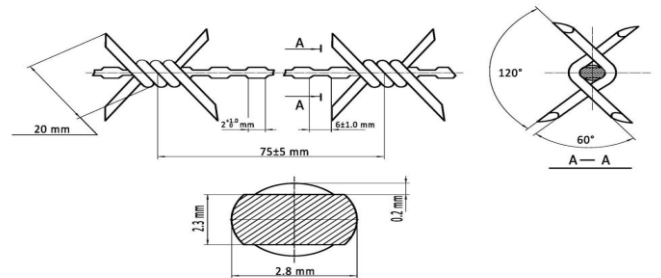

# GALVANİZLİ PUNTALI TEL

Height Yükseklik	100.125.150.200
Length Genişlik	25 m
Wire Dia. Tel Çapı	1.60 ..... 3.00
Vertical Wire Dia. Dikey Göz Arası	25 ..... 75
Horizontal Wire Dia. Yatay Göz Arası	50 ..... 100
Coating Kaplama	Galvanized

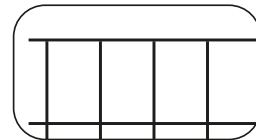
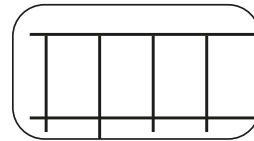
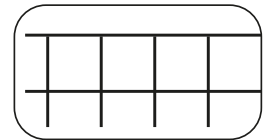
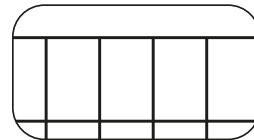
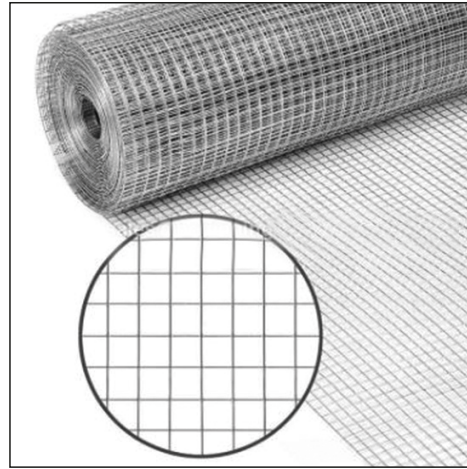
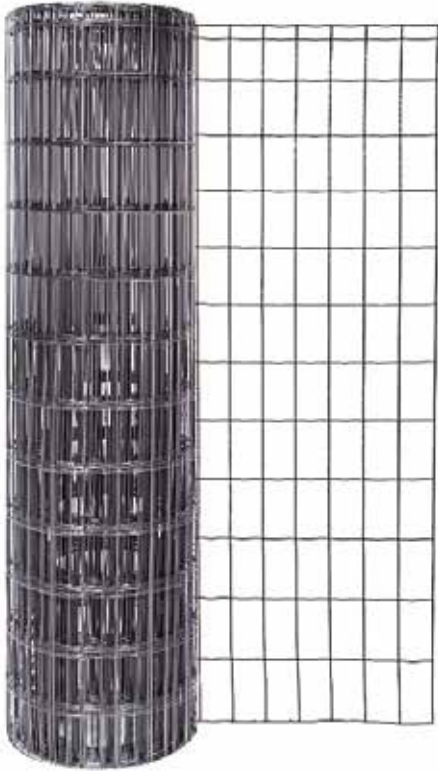

## KAYNAKLI HASIR TEL

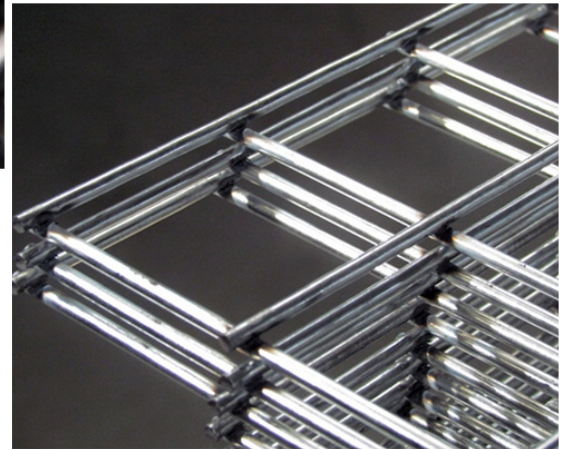

KAYNAKLI HASIRTEL		
GÖZ ARALIĞI	ÇAP	EBAT CM
20*20 MM	2.00 MM	100*200 / 120*240 (CM)
	2.20 MM	
	2.50 MM	
	2.65 MM	
	3.00 MM	
25*25 MM	2.00 MM	100*200 / 120*240 (CM)
	2.20 MM	
	2.50 MM	
	2.65 MM	
	3.00 MM	
30*30 MM	2.50 MM	100*200 / 120*240 150*200 / 200*200 (CM)
	2.65 MM	
	3.00 MM	
	3.65 MM	
	4.00 MM	
20*50 MM	2.20 MM	100*200 / 120*240 150*200 / 200*200 (CM)
	2.50 MM	
30*50 MM	2.50 MM	100*200 / 120*240 150*200 / 200*200 (CM)
	2.65 MM	
	3.00 MM	
	3.65 MM	

KAYNAKLI HASIRTEL		
GÖZ ARALIĞI	ÇAP	EBAT
40*40 MM	2.65 MM	100*200 / 120*240 150*200 / 200*200 (CM)
	3.00 MM	
	3.65 MM	
	4.00 MM	
	5.00 MM	
50*50 MM	3.00 MM	100*200 / 120*240 150*200 / 200*200 (CM)
	3.40 MM	
	3.65 MM	
	4.00 MM	
	4.80 MM	
60*60 MM	3.00 MM	100*200 / 120*240 150*200 / 200*200 (CM)
	3.65 MM	
	4.00 MM	
	5.00 MM	
70*70 MM	3.00 MM	100*200 / 120*240 150*200 / 200*200 (CM)
	3.65 MM	
	4.00 MM	
50*100 MM	3.00 MM	100*200 / 120*240 150*200 / 200*200 (CM)
	3.65 MM	
	4.00 MM	

# KN PANEL KAPI



## Tek Kanat Kapi

## Çift Kanat Kapi

	Medium Type	Pro Type
Post Profile Direk Profil	60x60x1,5 mm	60x60x1,5 mm 80x80x2,5 mm
Leaf Profile Kanat Profil	50x50x1,5 mm	60x60x1,5 mm
Leaf Panel Kapi Paneli	Ø 4 mm Single panel	Ø 5 mm Single panel
Lock & Handle Kilit & Kol	Standart	
Hinges Menteşe	DM Type	DM Pro Type
Height Yükseklik	1000 / 1200 / 1500 / 1700 / 2000 mm	
	2000 mm	5000 mm

	Med	Pro
Post Profile Direk Profil	50x50x1,5 mm	80x80x3 mm
Leaf Profile Kanat Profil	50x50x1,5 mm	40x60x2 mm
Leaf Panel Kapi Paneli	Ø 4 mm Single panel	Ø 5 mm Single panel
Lock & Handle Kilit & Kol	Standart	
Hinges Menteşe	DM Type	DM Pro Type
Height Yükseklik	1000 / 1200 / 1500 / 1700 / 2000 mm	
Length Genişlik	1000 mm	

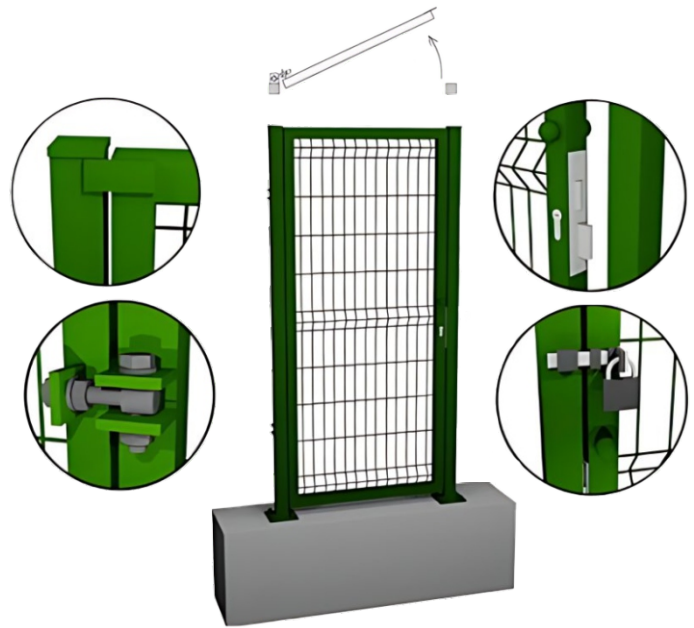

## 2D DOUBLE KAPI

## 2D Double Tek Kanat Kapi

	Medium Type	Pro Type
Post Profile Direk Profil	60x60x2 mm	80x80x3 mm
Leaf Profile Kanat Profil	40x60x2 mm	40x60x2 mm
Leaf Panel Kapi Paneli	6*5*6 Double Panel	8*6*8 Double Panel
Lock & Handle Kilit & Kol	Locinox	
Hinges Menteşe	Locinox	
Height Yükseklik	600 / 800 / 1000 / 1200 / 1400 / 1600 1800 / 2000 / 2200 / 2400 mm	
Length Genişlik	1000 mm	

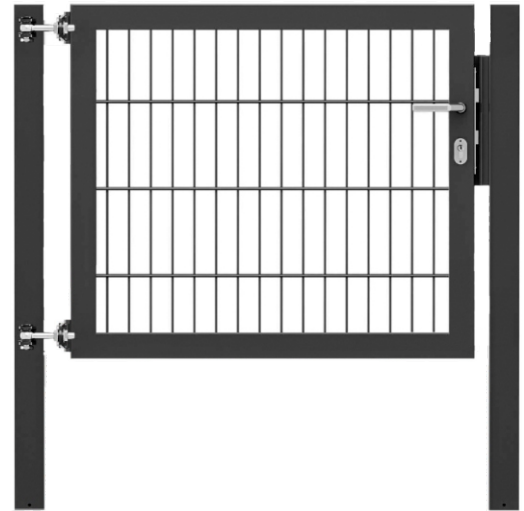
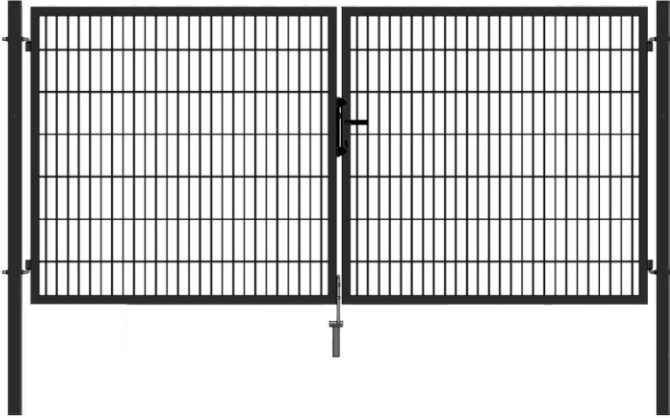

## 2D Double Çift Kanat Kapi

	Pro Type
Post Profile Direk Profil	80x80x2,5 mm
Leaf Profile Kanat Profil	40x60x2 mm
Leaf Panel Kapi Paneli	8*6*8 Double Panel
Lock & Handle Kilit & Kol	Locinox
Hinges Menteşe	Locinox
Height Yükseklik	600 / 800 / 1000 / 1200 / 1400 / 1600 1800 / 2000 / 2200 / 2400 mm
Length Genişlik	2000 ... 5000 mm

# KN SINGLE PANEL KAPI



## Single Tek Kanat Kapi

Horizontal Bars Yatay Kayıt	30x20x1,5 mm
Leaf Post Kanal Profili	40x40x1,5 mm
Gate Post Kapi Profili	60x60x2mm
Infill Kapi İçi	... Single Panel 4 mm 55x200 göz
Coating Kaplama	... Galvaniz üzeri polyester kaplama
Height Yükseklik	1000 / 1200 / 1500 / 1700 / 2000 mm
Length Genişlik	1000 mm

## Single Çift Kanat Kapi

Horizontal Bars Yatay Kayıt	30x20x1,5 mm
Leaf Post Kanal Profili	40x40x1,5 mm
Gate Post Kapi Profili	60x60x2mm
Infill Kapi İçi	... Single Panel 4 mm 55x200 göz
Coating Kaplama	... Galvaniz üzeri polyester kaplama
Height Yükseklik	1000 / 1200 / 1500 / 1700 / 1900 / 2000 mm
Length Genişlik	2000 mm ... 6000 mm

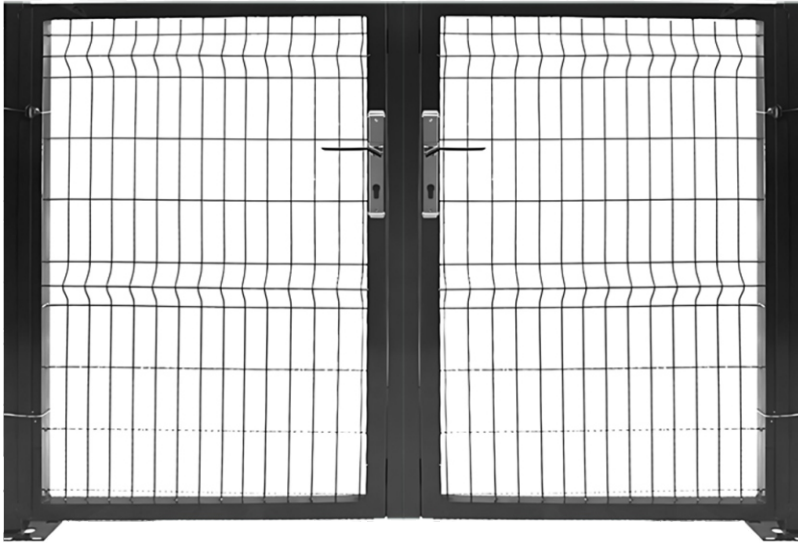

# KN PRO PANEL KAPI



## Pro Tek Kanat Kapi



Horizontal Bars Yatay Kayıt	30x20x1,5 mm
Leaf Post Kanal Profili	40x40x1,5 mm
Gate Post Kapi Profili	60x60x2 mm
Infill Kapi İçi	Single Panel 4 mm 55x200 Mesh Single Panel 4 mm 55x200 Göz
Coating Kaplama	Polyester Coating Over Galvanized Surface Galvaniz Üzeri Polyester Kaplama
Height Yükseklik	1000 / 1200 / 1500 / 1700 / 1900 / 2000 mm
Length Genişlik	1000 mm



Horizontal Bars Yatay Kayıt	30x20x1,5 mm
Leaf Post Kanal Profili	40x40x1,5 mm
Gate Post Kapi Profili	60x60x2mm
Infill Kapi İçi	Single Panel 4 mm 55x200 Mesh Single Panel 4 mm 55x200 Göz
Coating Kaplama	Polyester Coating Over Galvanized Surface Galvaniz Üzeri Polyester Kaplama
Height Yükseklik	1000 / 1200 / 1500 / 1700 / 1900 / 2000 mm
Length Genişlik	2000 ... 6000 mm

## KN RAYLI PANEL KAPI



## Raysız Kapi

## Sürgülü Kapi

Post Profile Direk Profil	RHS / SHS Profile Kutu Profil
Leaf Profile Kanat Profil	RHS / SHS Profile Kutu Profil
Leaf Panel Kapi Panel	Double Panel / Single Panel
Lock & Handle Kilit & Kol	Optional Opsiyonel
Rail Ray	Ø 18 mm Rod
Motor	Optional Opsiyonel
Height Yükseklik	1,00 .... 2,40 m
Length Genişlik	3,00 .... 12,00 m

Post Profile Direk Profil	RHS / SHS Profile Kutu Profil
Leaf Profile Kanat Profil	RHS / SHS Profile Kutu Profil
Leaf Panel Kapi Panel	Double Panel / Single Panel
Lock & Handle Kilit & Kol	Optional Opsiyonel
Rail Ray	Ø 18 mm rod
Motor	Optional Opsiyonel
Height Yükseklik	1,00 .... 2,40 m
Length Genişlik	3,00 .... 12,00 m

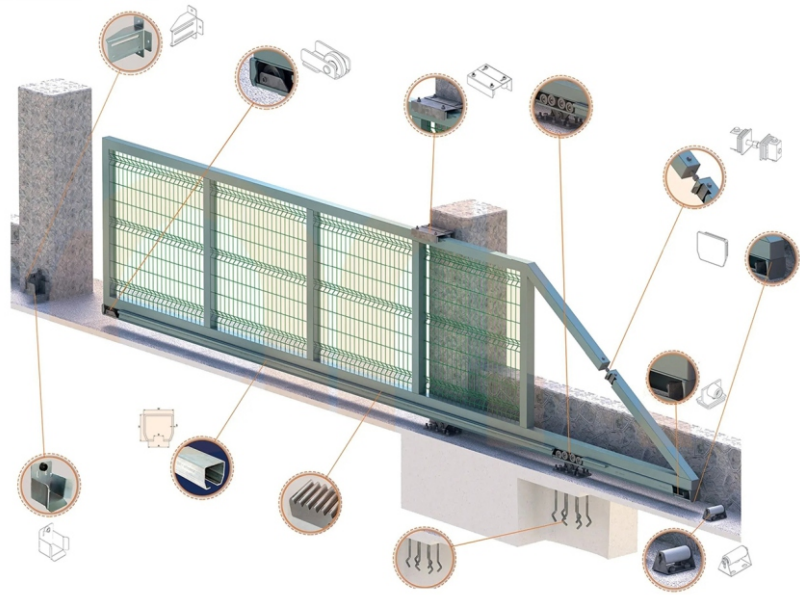
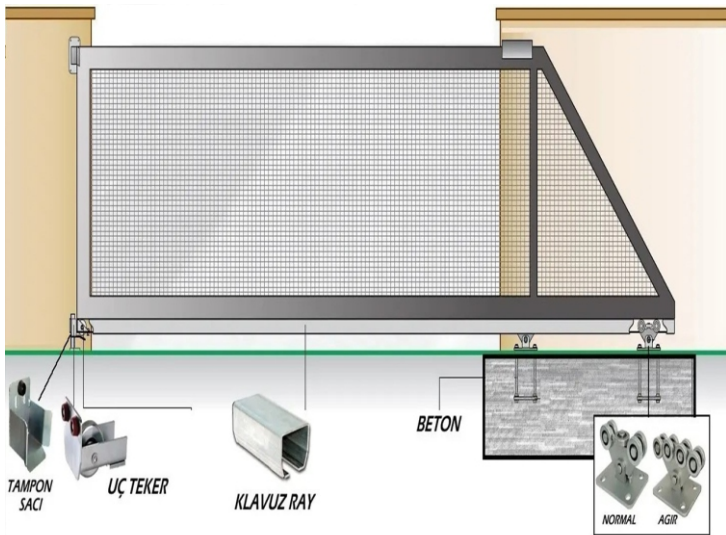

# SPOR ALANLARI İÇİN

En İyi Seçeneği Sunuyoruz



"Sınırlarınızı | s i n c e  
Belirliyoruz" | 1972

[www.konaktelcit.com](http://www.konaktelcit.com)

## SPOR SAHALARI (KLEMLİ)



UV Resistant Coating Applied to the Surface of the Optional Resistance after Precoat Increasing the Coating  
UV Dayanımlı Precoat Kaplamadan sonra İsteğe Bağlı Uygulanan Yüzey Direncini Arttıran Şeffaf Kaplamadır

%100 Acrylic Undercoat the Surface Coating is the Editor  
%100 Akrilik Esaslı Cushion Kaplamadır

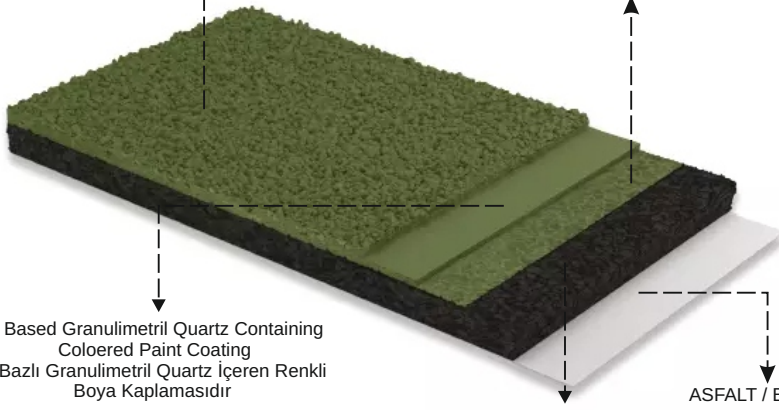

Acrylic Based Granulimetric Quartz Containing Colored Paint Coating  
Akrilik Bazlı Granulimetric Quartz İçeren Renkli Boya Kaplamasıdır

ASFALT / BETON

%100 Acrylic Cushion Coatings  
%100 Akrilik Esaslı Cushion Astarıdır

Natural Grass  
Doğal Çim

Sand Layer  
Kum Tabakası

Aggregate Layer  
Agrega Katmanı

Perforated Drainage Pipe  
Perfore Drenaj Borusu

Subbase  
Alt Taban

Natural Soil  
Doğal Toprak

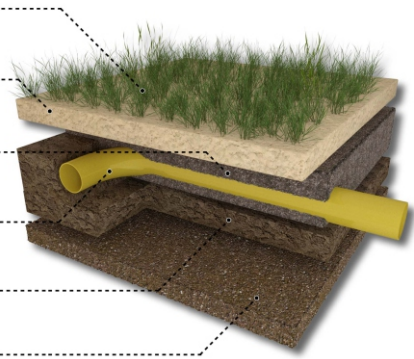

## CLAMP TYPES / KLEMP TİPLERİ

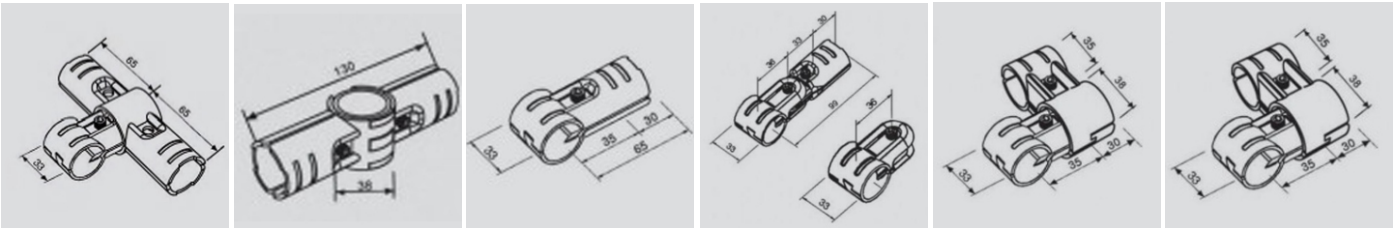





"Sınırlarınızı  
Belirliyoruz" | since  
1972

FABRİKA 1



FABRİKA 2



[www.konaktelcit.com](http://www.konaktelcit.com)



FABRİKA 1  
Yavuz sultan selim mahallesi. 131.cad. No. 41. Aksaray



FABRİKA 2  
Kırımlı OSB Mah. Şehit Dursun Çetin Sokak No 15 Merkez /Aksaray



+90 (382) 502 33 00 • +90 (382) 502 33 01



+90 (549) 641 68 00



konakdemircelik@hotmail.com • nfo@ikonexport.com.tr